

Choose
Aluminum

Al premium
SALT AND BRACKISH WATER

Anodes for
salt and brackish
water and
Magnesium

Mg fresh
FRESH WATER ONLY
for freshwater.

SUZUKI™ ANODE KITS

ALL KITS INCLUDE FASTENING HARDWARE, INSTALLATION INSTRUCTIONS,
AND ALL OF THE ANODES REQUIRED FOR 100% PROTECTION.



	PID	LB	KG	Contains	Fits	UPC
Al	CMSZ4050KITA	0.859	0.390	CM5532095310 X 2 CM5532187J00 X 4 CM5512595500 X 1	Suzuki 40-50 HP	6 28309 24967 0
Mg	CMSZ4050KITM	0.546	0.248			6 28309 24968 7
Zn	CMSZ4050KITZ	1.190	0.540			6 28309 24969 4



	PID	LB	KG	Contains	Fits	UPC
Al	CMSZ90140KITA	0.848	0.385	CM5532190J01 X 1 CM5532187J00 X 4 CM3C7602181A0 X 1	Suzuki 90-100-115 -140 HP	6 28309 24962 5
Mg	CMSZ90140KITM	0.688	0.312			6 28309 24963 2
Zn	CMSZ90140KITZ	1.724	0.782			6 28309 24964 9



	PID	LB	KG	Contains	Fits	UPC
Al	CMSZ150350KITA	1.036	0.47	CM3C7602181A0 X 1 CM5532187J00 X 8 CM5532095310 X 3	Suzuki 150-350 HP	6 28309 27228 9
Mg	CMSZ150350KITM	0.763	0.346			6 28309 27229 6
Zn	CMSZ150350KITZ	2.117	0.96			6 28309 27227 2

Martyr®
SUZUKI™ / VOLVO PENTAI™ ANODES

NEW
PRODUCTS

VOLVO PENTAI™ ANODES

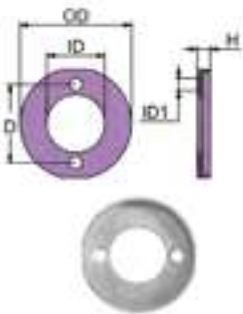

	PID	LB	KG		OD	D	ID	ID1	H	UPC
Al	CMV15A (CM875810A)	0.172	0.078	mm	98.8	69.5	51.2	11	11.5	6 28309 12355 0
Mg	CMV15M (CM875810M)	0.110	0.050							6 28309 19320 1
Zn	CMV15 (CM875810Z)	0.452	0.205	in	3.89	2.74	2.02	0.43	0.45	6 28309 10360 6

50-100 SERIES

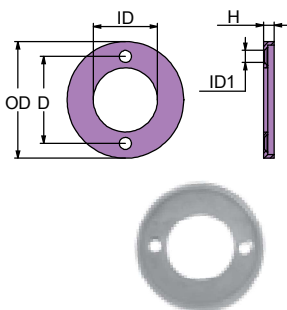

	PID	LB	KG		OD	D	ID	ID1	H	UPC
Al	CMV16A (CM875809A)	0.176	0.080	mm	106	79	58.3	11	10	6 28309 12356 7
Mg	CMV16M (CM875809M)	0.112	0.051							6 28309 19321 8
Zn	CMV16 (CM875809Z)	0.458	0.208	in	4.2	3.1	2.3	0.43	0.4	6 28309 10361 3

50-200 SERIES

VOLVO PENTA™ ANODES

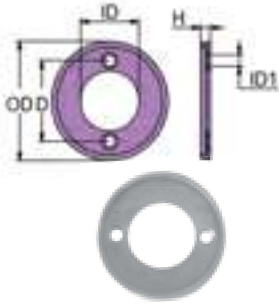

	PID	LB	KG		OD	D	ID	ID1	H	UPC
Al	CMV17A (CM875806-4A)	0.231	0.105	mm	116.5	79	58.3	11	10	6 28309 12357 4
Mg	CMV17M (CM875806-4M)	0.145	0.066							6 28309 19322 5
Zn	CMV17 (CM875806-4Z)	0.606	0.275	in	4.59	3.11	2.3	0.43	0.39	6 28309 10362 0

50-250-270-275-280-285 SERIES



	PID	LB	KG		L	H	D	OD	ID	ID1	UPC
Al	CMV18A (CM875815-3A)	0.64	0.29	mm	155	33.5	80	120	61	9	6 28309 12266 9
Mg	CMV18M (CM875815-3M)	0.4	0.18								6 28309 10364 4
Zn	CMV18 (CM875815-3Z)	1.16	0.73	in	6.1	1.32	3.15	4.72	2.4	0.35	6 28309 10363 7

280-290 E SINGLE DROP SERIES

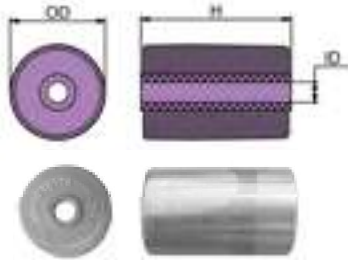

	PID	LB	KG		OD	H	ID	UPC
Al	CM21718129A	0.465	0.211	mm	38.9	61.5	8.3	6 28309 25162 8
Mg	CM21718129M	0.339	0.154					6 28309 25163 5
Zn	CM21718129Z	1.020	0.463	in	1.53	2.42	0.33	6 28309 25161 1

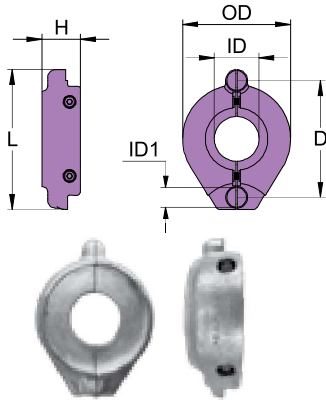

	PID	LB	KG		L	H	D	ID	ID1	OD	UPC
Zn	CM22651246Z	3.213	1.457	mm	141.1	39	118	45	20	109	6 28309 27309 5
				in	5.56	1.54	4.65	1.77	0.79	4.29	

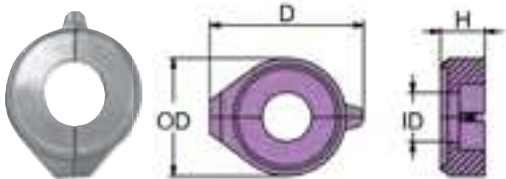

	PID	LB	KG		D	OD	ID	H	UPC
Al	CM358407A	1.338	0.607	mm	139	108	45	40	6 28309 12394 9
Mg	CM358407M	0.893	0.405						6 28309 12404 5
Zn	CM358407Z	3.355	1.522	in	5.47	4.25	1.77	1.57	6 28309 12325 3

SD 130/150 2002 2003 SERIES

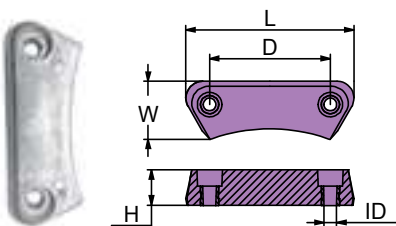

	PID	LB	KG		L	W	H	D	ID	UPC
Al	CM3588745A	0.445	0.202	mm	118	41	25	85	9	6 28309 17066 0
Mg	CM3588745M	0.284	0.129							6 28309 17067 7
Zn	CM3588745Z	1.082	0.491	in	4.6	1.6	1	3.4	0.35	6 28309 17068 4

DUO PROP

Protect your boat, respect our waters.

VOLVO PENTA™ ANODES

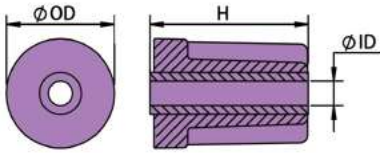

	PID	LB	KG		OD	ID	H	UPC
Al	CM3593881A	0.75	0.34	mm	49.1	10.5	72	6 28309 17069 1
Mg	CM3593881M	0.57	0.26					6 28309 19286 0
Zn	CM3593881Z	1.61	0.73	in	1.93	0.41	2.83	6 28309 17070 7

IPS

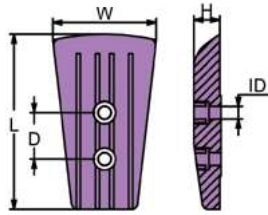
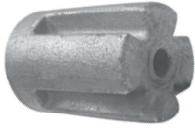

	PID	LB	KG		L	H	W	D	ID	UPC
Al	CM3589875A	0.72	0.33	mm	132.3	19.6	78	35	9.6	6 28309 21147 9
Mg	CM3589875M	0.50	0.23							6 28309 21169 1
Zn	CM3589875Z	1.82	0.83	in	5.20	0.77	3.07	1.38	0.38	6 28309 21148 6

VOLVO PENTA DPR PLATE

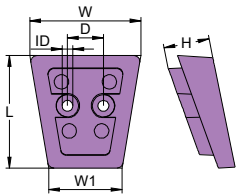

	PID	LB	KG		L	W	W1	H	D	ID	UPC
Al	CM3841427A	0.974	0.442	mm	94	93	61	38	30	9	6 28309 12636 0
Mg	CM3841427M	0.639	0.290								6 28309 15986 3
Zn	CM3841427Z	2.425	1.100	in	3.7	3.7	2.4	1.5	1.18	0.35	6 28309 12734 3

SX-A/APS-A

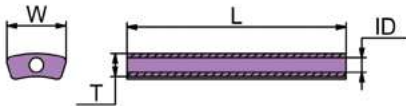

	PID	LB	KG		L	W	ID	T	UPC
Al	CM3852970A	0.150	0.068	mm	104	28	7	11	6 28309 12577 6
Mg	CM3852970M	0.095	0.043						6 28309 19287 7
Zn	CM3852970Z	0.389	0.176	in	4	1.1	0.26	0.42	6 28309 19250 1

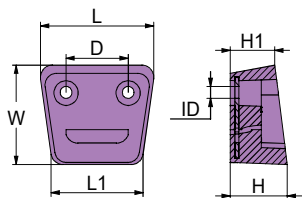

	PID	LB	KG		L	L1	W	H	H1	D	ID	UPC
Al	CM3854130A	0.930	0.422	mm	96	73	80	47	37	51	10	6 28309 12270 6
Mg	CM3854130M	0.613	0.278									6 28309 12608 7
Zn	CM3854130Z	2.319	1.052	in	3.76	2.86	3.14	1.84	1.44	2	0.38	6 28309 11378 0

S. DRIVE - SX DRIVE



Martyr® VOLVO PENTA™ ANODES

VOLVO PENTA™ ANODES

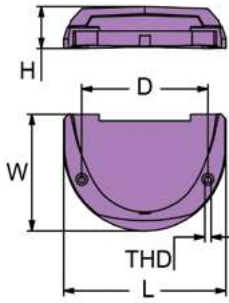

	PID	LB	KG		L	W	H	D	THD	UPC
Al	CM3855411A	0.948	0.430	mm	145	103	37	113	¼ - 20 UNC	6 28309 12269 0
Mg	CM3855411M	0.622	0.282							6 28309 12634 6
Zn	CM3855411Z	2.414	1.095	in	5.7	4	1.4	4.4		6 28309 11372 8

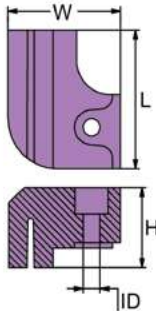

	PID	LB	KG		L	W	H	ID	UPC
Al	CM3861636A	0.214	0.097	mm	52	43	30	6.1	6 28309 17074 5
Mg	CM3861636M	0.136	0.062						6 28309 17075 2
Zn	CM3861636Z	0.520	0.236	in	2	1.7	1.2		0.24

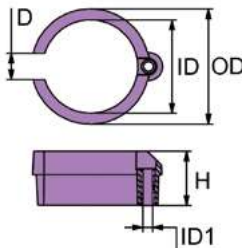

	PID	LB	KG		OD	ID	ID1	D	H	UPC
Al	CM3861634A	0.262	0.119	mm	78	64	6.1	18	37	6 28309 17071 4
Mg	CM3861634M	0.169	0.077							6 28309 17072 1
Zn	CM3861634Z	0.672	0.305	in	3.1	2.52	0.24	0.71		1.5

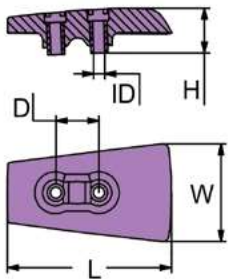

	PID	LB	KG		L	W	H	D	ID	UPC
Al	CM3863206A	0.771	0.350	mm	132	78	36	35	9	6 28309 12722 0
Mg	CM3863206M	0.485	0.220							6 28309 17606 8
Zn	CM3863206Z	1.962	0.890	in	5.2	3.1	1.4	1.4		0.35

DPH/DPR SERIES

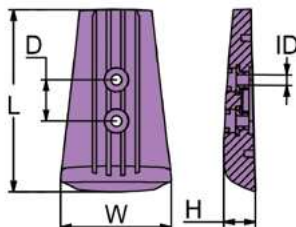

	PID	LB	KG		L	W	H	D	ID	UPC
Al	CM3883728A	1.1	0.5	mm	153	91	27	34.6	9	6 28309 12720 6
Mg	CM3883728M	0.71	0.32							6 28309 15987 0
Zn	CM3883728Z	2.89	1.31	in	6	3.6	1.1	1.36		0.4



VOLVO PENTA™ ANODES

**NEW
PRODUCT**

VOLVO PENTA™ ANODES

Choose Aluminum
Al premium
SALT AND BRACKISH WATER

Anodes for salt and brackish water and Magnesium

Mg fresh
FRESH WATER ONLY
for freshwater.

	PID	LB	KG		L	ID	W	H	W1	D	D1	UPC
Al	CM40005206A	4.63	2.10	mm	346	7.7	72	30	10.6	150	5.5	6 28309 25521 3
Mg	CM40005206M	2.99	1.36									6 28309 25526 8
Zn	CM40005206Z	11.81	5.36	in	13.62	0.30	2.83	1.18	0.42	5.90	0.21	6 28309 25516 9

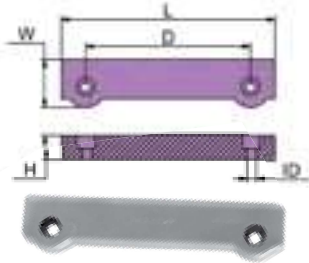
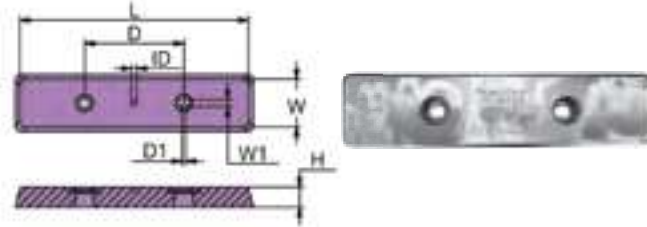

	PID	LB	KG		L	W	H	D	ID	UPC
Al	CM832598A	0.81	0.37	mm	188	41	22	145	8	6 28309 12265 2
Mg	CM832598M	0.52	0.24							6 28309 10125 1
Zn	CM832598Z	2.09	0.95	in	7.4	1.6	0.9	5.7	0.3	6 28309 10126 8

250-270-275-280-285 SERIES

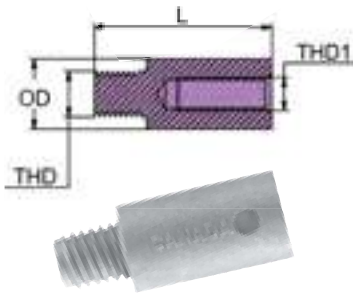

	PID	LB	KG		L	OD	THD	THD1	UPC
Al	CM838929A	0.040	0.018	mm	43	17	7/16	M8	6 28309 12328 4
Mg	CM838929M	0.025	0.011			- 14			6 28309 19298 3
Zn	CM838929Z	0.090	0.041	in	1.7	0.67	UNC		6 28309 10128 2

200-250-270 SERIES

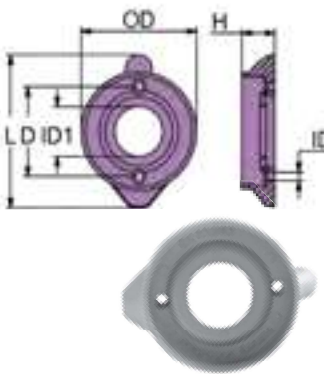

	PID	LB	KG		L	D	OD	ID	ID1	H	UPC
Al	CM851983A	0.441	0.200	mm	124	72.5	96	7	40	27	6 28309 12326 0
Mg	CM851983M	0.286	0.130								6 28309 12190 7
Zn	CM851983Z	1.080	0.490	in	4.9	2.85	3.8	0.26	1.57	1.1	6 28309 10134 3

S. DRIVE 120 SERIES

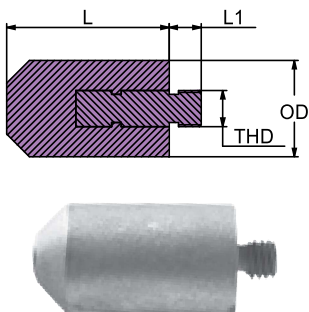

	PID	LB	KG		L	L1	OD	THD	UPC
Al	CM823661A	0.145	0.066	mm	43	9.4	26	3/8 - 16 UNC	6 28309 10118 3
Mg	CM823661M	0.106	0.048						6 28309 12327 7
Zn	CM823661Z	0.308	0.140	in	1.7	0.4	1		6 28309 12374 1

Martyr
VOLVO PENTA™ ANODES

VOLVO PENTA™ ANODES

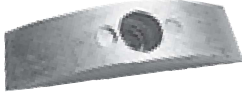
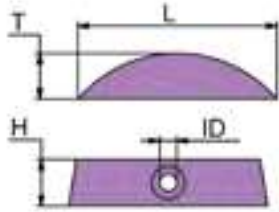

	PID	LB	KG		L	H	T	ID	UPC
Al	CM852018A (CM850982A)	0.044	0.020	mm	64	15	15	5.84	6 28309 11522 7
Mg	CM852018M (CM850982M)	0.028	0.013						6 28309 12330 7
Zn	CM852018Z (CM850982Z)	0.112	0.051	in	2.5	0.59	0.57	0.23	6 28309 19299 0

110-120, S-B, S-C SERIES

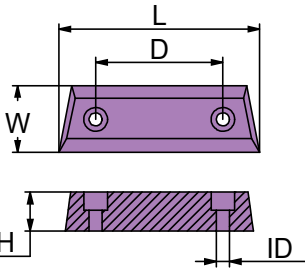

	PID	LB	KG		L	W	H	D	ID	UPC
Al	CM852835A	0.639	0.290	mm	136	46	26	86	9	6 28309 12268 3
Mg	CM852835M	0.423	0.192							6 28309 10135 0
Zn	CM852835Z	1.785	0.810	in	5.35	1.81	1	3.4	0.33	6 28309 10136 7

DUO PROP 290 SERIES

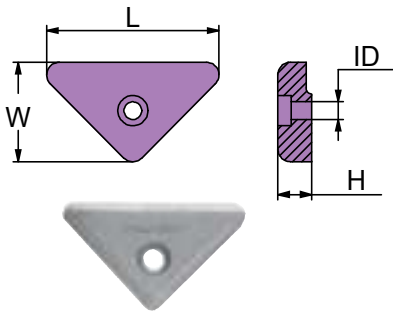

	PID	LB	KG		L	W	H	ID	UPC
Al	CM872793A	0.100	0.045	mm	66	38	13	6	6 28309 12332 1
Mg	CM872793M	0.060	0.027						6 28309 17046 2
Zn	CM872793Z	0.240	0.109	in	2.6	1.5	0.5	0.25	6 28309 11367 4

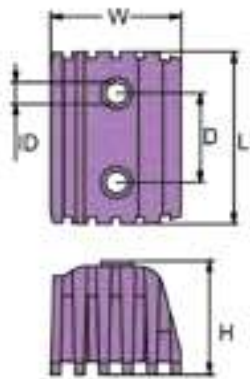

	PID	LB	KG		L	W	H	D	ID	UPC
Al	CM873395A	0.236	0.107	mm	54	41	36	28	6.7	6 28309 12637 7
Mg	CM873395M	0.158	0.072							6 28309 15988 7
Zn	CM873395Z	0.613	0.278	in	2.1	1.6	1.4	1.1	0.24	6 28309 12736 7

DPX SERIES

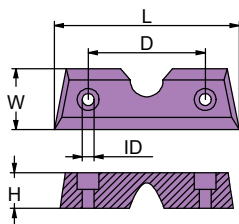
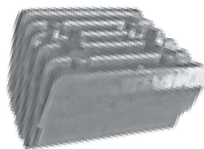

	PID	LB	KG		L	W	H	D	ID	UPC
Al	CM872139A	0.595	0.270	mm	136	46	26	86	9	6 28309 12331 4
Mg	CM872139M	0.374	0.170							6 28309 19301 0
Zn	CM872139Z	1.543	0.700	in	5.35	1.8	1	3.4	0.33	6 28309 11366 7

DPX SERIES

Protect your boat, respect our waters.

VOLVO PENTA™ ANODES

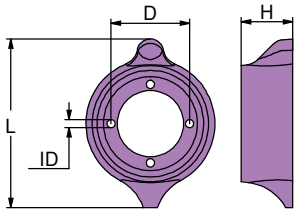

	PID	LB	KG		L	H	D	ID	UPC
Al	CM875812A	0.778	0.353	mm	140	43	65	6	6 28309 12333 8
Mg	CM875812M	0.489	0.222						6 28309 10141 1
Zn	CM875812Z	2.019	0.916	in	5.5	1.7	2.55	0.25	6 28309 10140 4

S. DRIVE 110 SERIES

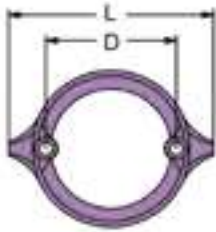

	PID	LB	KG		L	H	D	ID	UPC
Al	CM875821A	0.447	0.203	mm	145	29	92	9	6 28309 12267 6
Mg	CM875821M	0.289	0.131						6 28309 10141 1
Zn	CM875821Z	1.144	0.519	in	5.7	1.2	3.63	0.34	6 28309 10142 8

DUO PROP 290 SERIES

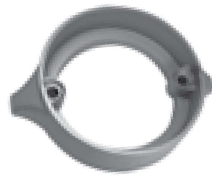
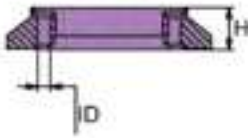

	PID	LB	KG		L	W	H	D	D1	W1	UPC
Al	CM40005875A	3.19	1.45	mm	268	85	30	138	5	10	6 28309 17079 0
Mg	CM40005875M	1.96	0.89								6 28309 17077 6
Zn	CM40005875Z	8.04	3.65	in	10.5	3.3	1.2	5.4	0.21	0.41	6 28309 17078 3

IPS

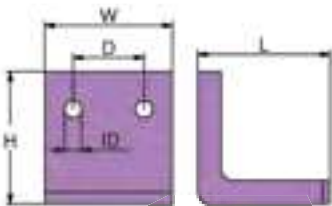
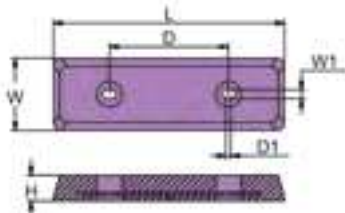

	PID	LB	KG		L	W	H	D	ID	UPC
Al	CM832934A	0.55	0.25	mm	56	56	54	26	9	6 28309 23500 0
Mg	CM832934M	0.35	0.16							6 28309 23501 7
Zn	CM832934Z	1.46	0.66	in	2.2	2.2	2.1	1	0.35	6 28309 23502 4

BRACKET TRIM 270



Martyr®
VOLVO PENTA™ ANODES

VOLVO PENTA™ ANODES

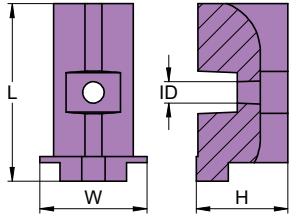

	PID	LB	KG		L	W	H	ID	UPC
Al	CM855105A	0.125	0.057	mm	58	35	29.5	7	6 28309 20943 8
Mg	CM855105M	0.0793	0.036						6 28309 20964 3
Zn	CM855105Z	0.328	0.149	in	2.28	1.38	1.16	0.28	6 28309 20985 8

S. DRIVE SERIES

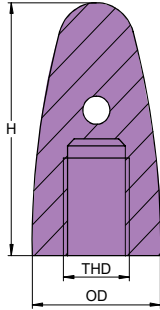
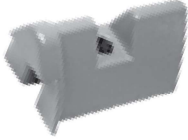

	PID	LB	KG		OD	H	THD	Shaft	UPC
Al	CM833913A	0.249	0.113	mm	37	70	3/4 - 10 UNC	22-25	6 28309 20961 2
Mg	CM833913M	0.158	0.072						6 28309 20982 7
Zn	CM833913Z	0.643	0.292	in	1.46	2.76			6 28309 20940 7
Al	CM833915A	0.233	0.106	mm	37	70	7/8 - 9 UNC	30	6 28309 20962 9
Mg	CM833915M	0.147	0.067						6 28309 20983 4
Zn	CM833915Z	0.604	0.274	in	1.46	2.76			6 28309 20941 4
Al	CM828140A	0.394	0.179	mm	46	80	1 - 8 UNC	40-45	6 28309 20960 5
Mg	CM828140M	0.251	0.114						6 28309 20981 0
Zn	CM828140Z	1.025	0.465	in	1.81	3.15			6 28309 20939 1

DPX SERIES

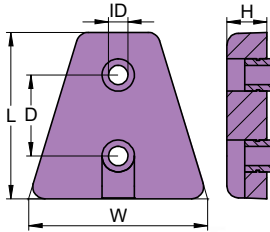

	PID	LB	KG		L	W	H	ID	D	UPC
Al	CM876638A	0.163	0.074	mm	56	60	13	7	27	6 28309 24181 0
Mg	CM876638M	0.139	0.063							6 28309 24291 6
Zn	CM876638Z	0.571	0.259	in	2.2	2.36	0.51	0.28	1.06	6 28309 24114 8

DPX SERIES

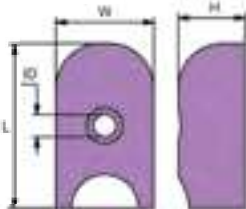

	PID	LB	KG		L	W	H	ID	UPC
Al	SGSP71180A	0.039	0.018	mm	37	22	15	7	6 28309 22627 5
Mg	SGSP71180M	0.024	0.011						6 28309 22847 7
Zn	SGSP71180Z	0.101	0.046	in	1.5	0.9	0.6	0.3	6 28309 22311 3

BOW THRUST

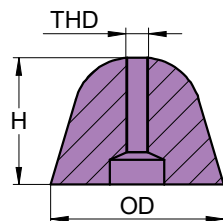

	PID	LB	KG		OD	H	THD	UPC
Al	CM41100098A	0.048	0.022	mm	30	22	M4	6 28309 20953 7
Mg	CM41100098M	0.031	0.014					6 28309 20974 2
Zn	CM41100098Z	0.128	0.058	in	1.2	0.9		6 28309 20932 2

OGIVE BOW THRUST

VOLVO PENTA™ ANODES

Choose
Aluminum

Al premium
SALT AND BRACKISH WATER

Anodes for
salt and brackish
water and
Magnesium

Mg fresh
FRESH WATER ONLY
for freshwater.

VOLVO PENTA™ ANODES

	PID	LB	KG		L	W	ID	T	UPC
Al	CM41100276A	0.072	0.033	mm	51	25	7	16	6 28309 23341 9
Mg	CM41100276M	0.046	0.021						6 28309 23342 6
Zn	CM41100276Z	0.187	0.085	in	2	1	0.26	0.62	6 28309 23343 3

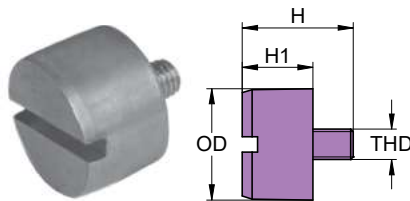
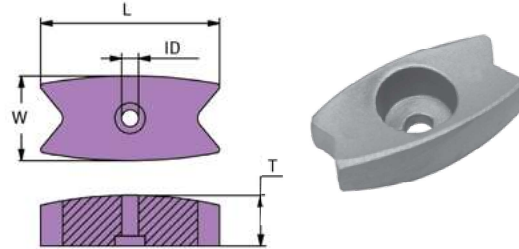

	PID	LB	KG		OD	H	H1	THD	UPC
Al	CM8520219A	0.037	0.017	mm	22	22	14	M6 x 1	6 28309 20963 6
Mg	CM8520219M	0.028	0.013						6 28309 20984 1
Zn	CM8520219Z	0.079	0.036	in	0.9	0.9	0.5		6 28309 20942 1

SEAL DRIVE 100

VOLVO PENTA™ ANODE KITS

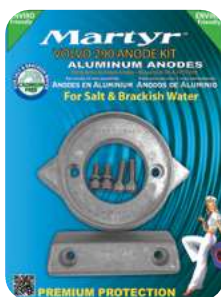

	PID	LB	KG	Contains	Fits	UPC
Al	CM280KITA	1.651	0.749	CMV18 X 1 CM832598 X 1	Volvo 280 Engine	6 28309 12286 7
Mg	CM280KITM	1.177	0.534			6 28309 12797 8
Zn	CM280KITZ	3.922	1.779			6 28309 12802 9

	PID	LB	KG	Contains	Fits	UPC
Al	CM280DPKITA	1.708	0.775	CM875821 X 1 CM832598 X 1	Volvo 280 Dual Prop Engine	6 28309 12287 4
Mg	CM280DPKITM	1.300	0.590			6 28309 12798 5
Zn	CM280DPKITZ	3.708	1.682			6 28309 12803 6

	PID	LB	KG	Contains	Fits	UPC
Al	CM290KITA	1.653	0.750	CMV18 X 1	Volvo 290	6 28309 12288 1
Mg	CM290KITM	1.208	0.548			6 28309 12799 2
Zn	CM290KITZ	3.686	1.672	CM852835 X 1	Engine	6 28309 12804 3

Martyr®
VOLVO PENTA™ ANODES

VOLVO PENTA™ ANODE KITS

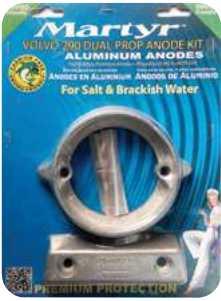

	PID	LB	KG	Contains	Fits	UPC
Al	CM290DPKITA	1.44	0.65	CM875821 X 1 CM852835 X 1	Volvo 290 Dual Prop Engine	6 28309 12289 8
Mg	CM290DPKITM	1.067	0.484			6 28309 12800 5
Zn	CM290DPKITZ	3.285	1.490			6 28309 12805 0

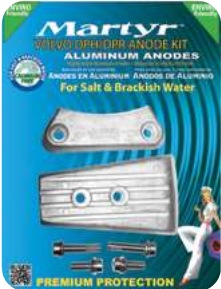

	PID	LB	KG	Contains	Fits	UPC
Al	CMDPHKITA	1.748	0.793	CM3588745 X 1 CM3863206 X 1	Volvo DPH Engine	6 28309 17047 9
Mg	CMDPHKITM	1.340	0.608			6 28309 17048 6
Zn	CMDPHKITZ	3.532	1.602			6 28309 17049 3



	PID	LB	KG	Contains	Fits	UPC
Al	CMSXKITA	2.2432	1.0175	CM3855411 X 1 CM3854130 X 1	Volvo SX Engine	6 28309 12290 4
Mg	CMSXKITM	1.5995	0.7255			6 28309 12801 2
Zn	CMSXKITZ	5.0938	2.3105			6 28309 12806 7



	PID	LB	KG	Contains	Fits	UPC
Al	CMSXAKITA	2.38	1.08	CM3841427 X 1 CM3883728 X 1	Volvo SX-A/DPS Engine	6 28309 17050 9
Mg	CMSXAKITM	1.67	0.76			6 28309 17051 6
Zn	CMSXAKITZ	5.62	2.55			6 28309 17052 3

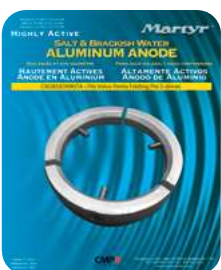

	PID	LB	KG	Contains	Fits	UPC
Al	CM3858399KITA	0.401	0.182	CM3858286 X 3	Volvo Folding Prop 3-blade Engine D2-55A, B, C, D, E, F	6 28309 15934 4
Mg	CM3858399KITM	0.324	0.147			6 28309 15935 1
Zn	CM3858399KITZ	0.782	0.355			6 28309 15933 7

VOLVO PENTA™ ANODES

Protect your boat, respect our waters.

VOLVO PENTA™ ANODE KITS



	PID	LB	KG	Contains	Fits	UPC
Al	CM290EUKITA	1.85	0.84	CMV18 X 1 CM852835 X 1 CM872793 X 2	Fits Volvo Penta 290	6 28309 25508 4
Mg	CM290EUKITM	1.32	0.60			6 28309 25509 1
Zn	CM290EUKITZ	3.74	1.70			6 28309 25510 7



	PID	LB	KG	Contains	Fits	UPC
Al	CM290DPEUKITA	1.67	0.76	CM875821 X 1 CM852835 X 1 CM872793 X 1	Fits Volvo Penta 290DP	6 28309 25505 3
Mg	CM290DPEUKITM	1.23	0.56			6 28309 25506 0
Zn	CM290DPEUKITZ	2.2	0.54			6 28309 25507 7



	PID	LB	KG	Contains	Fits	UPC
Al	CM3584442KITA	0.410	0.186	CM3584442D X 3	Volvo 4-Blade Folding Prop	6 28309 25511 4
Mg	CM3584442KITM	0.313	0.142			6 28309 25512 1
Zn	CM3584442KITZ	0.796	0.361			6 28309 25513 8



	PID	LB	KG	Contains	Fits	UPC
Al	CM872793KITA	0.2	0.09	CM872793 X 2	Fits Volvo Penta 290, 290DP, XDP & DPX	6 28309 18957 0
Mg	CM872793KITM	0.12	0.054			6 28309 18958 7
Zn	CM872793KITZ	0.48	0.22			6 28309 18959 4



	PID	LB	KG	Contains	Fits	UPC
Al	CMVPIPSKITA	4.18	1.90	CM3593881 X 1 CM40005875 X 1	Volvo Penta IPS SternDrive	6 28309 26012 5
Mg	CMVPIPSKITM	2.77	1.26			6 28309 26034 7
Zn	CMVPIPSKITZ	9.86	4.48			6 28309 25988 4

YAMAHA™ ANODES

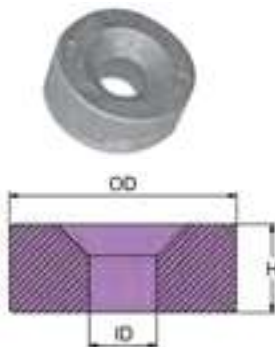

	PID	LB	KG		OD	ID	H	UPC
Al	CM41106ZW000A	0.0149	0.0067	mm	22	6.5	8.5	6 28309 23347 1
Mg	CM41106ZW000M	0.0095	0.0043					6 28309 23348 8
Zn	CM41106ZW000Z	0.0386	0.0175	in	0.86	0.25	0.33	6 28309 23349 5

2 - 115 HP / MARINER 2 - 25 HP / YAMAHA 2 - 25 HP

YAMAHA™ ANODES

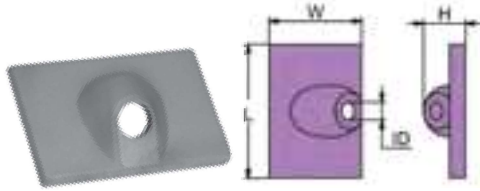

	PID	LB	KG		L	W	H	ID	UPC
Al	CM42121A	0.024	0.011	mm	42	29	11	7	6 28309 20954 4
Mg	CM42121M	0.015	0.007						6 28309 20975 9
Zn	CM42121Z	0.059	0.027	in	1.66	1.1	0.42	0.28	6 28309 20933 9

6-9.9 HP MARINER

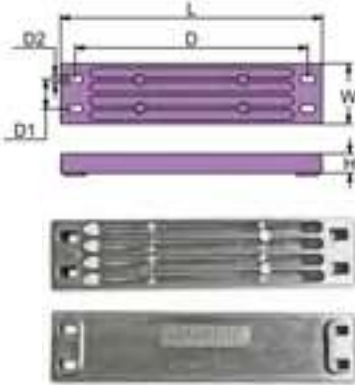

	PID	LB	KG		L	W	H	D	D1	D2	UPC
Al	CM6AW4525100A	0.56	0.25	mm	203	47	15	180.35	23	6.2	6 28309 25540 4
Mg	CM6AW4525100M	0.35	0.16								6 28309 25545 9
Zn	CM6AW4525100Z	1.46	0.66	in	7.99	1.85	0.59	7.1	0.90	0.24	6 28309 25535 0

YAMAHA OB ENGINE ANODE 6AW-45251-00

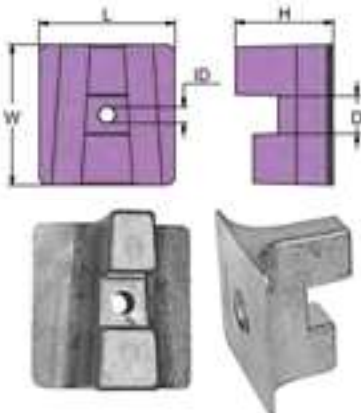

	PID	LB	KG		L	W	H	ID	D	UPC
Al	CM6AW4537300A	0.93	0.42	mm	90	93	35.5	11	25	6 28309 25541 1
Mg	CM6AW4537300M	0.59	0.27							6 28309 25546 6
Zn	CM6AW4537300Z	2.42	1.09	in	3.54	3.66	1.39	0.43	0.98	6 28309 25536 7

YAMAHA OB ENGINE ANODE 6AW-45373-00

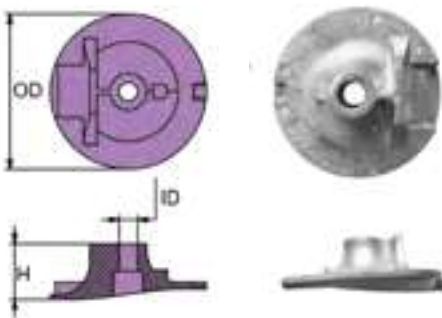

	PID	LB	KG		OD	ID	H	UPC
Al	CM6AW4561900A	0.227	0.103	mm	88.9	10.5	32	6 28309 25995 2
Mg	CM6AW4561900M	0.145	0.066					6 28309 26019 4
Zn	CM6AW4561900Z	0.595	0.27	in	3.5	0.41	1.26	6 28309 25972 3

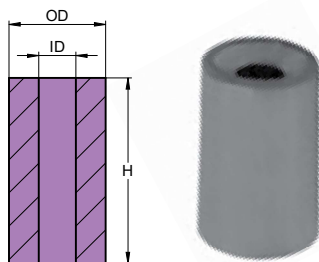

	PID	LB	KG		OD	ID	H	UPC
Al	CM6BL1132500A	0.015	0.007	mm	13	5	25	6 28309 23215 3
Mg	CM6BL1132500M	0.009	0.004					6 28309 23229 0
Zn	CM6BL1132500Z	0.04	0.02	in	0.51	0.2	1	6 28309 23198 9

YAMAHA™ ANODES

**NEW
PRODUCTS**